

### General Information

Ruby bearings and a non-drag pick-off give these adjustable insertion turbine flow sensors a wide flow and long life. A sensor detects the passage of miniature magnets in the rotor blades. (Magnets are in 2 or 4 blades only.) The resulting square-wave signal can be sent for hundreds of feet without a transmitter, over unshielded cable. This signal can be connected directly to many PLC's and other controls without any additional electronics.

Installation fittings are standard 1-1/2" NPT. A depth adjustment system allows two basic sizes to cover pipe sizes from 2" to 48". Fittings such as saddles and weldolets may be purchased locally, and are also available from SeaMetrics.

A modular system of electronics can be installed directly on the flow sensor, in a splashproof cast housing. The FT415/420 provide digital rate and total display, as well as programmable pulse. The FT420 also provides a 4-20 mA analog output. The AO55 is a blind analog transmitter. Programmable pulse for pump pacing comes from the PD10. Each of these controls is also available in a wall mount housing.

### Specifications

<b>Sensor</b>	Hall-Effect Sensor	12 VDC current sinking pulse
<b>Materials</b>	Sensor body	Brass, 316 SS
	Rotor	Polypro, PVDF (optional)
	Bearings	Ruby
	Shaft	Nickel-bound tungsten carbide, zirconia ceramic optional
<b>Range</b>		0.2 - 30 FPS (.006-9 M/s)
<b>Accuracy</b>		+/- 1% FS
<b>Maximum Pressure</b>		200 psi (14 bar)
<b>Maximum Temperature</b>		200° F (93°C)
<b>Pipe Size</b>	TX101	2" - 10" (50-250mm)
	TX201	10" - 48" (250-1200mm)
<b>Fitting Size</b>		1-1/2" NPT
<b>Insertion Force</b>		0.44 x pressure in pipe
<b>Power</b>		5 - 24 VDC, 1.5 mA
<b>Cable</b>		#22 AWG 3-con, 18' (6m)
<b>Max. Cable Run</b>		2,000 ft. (650m)

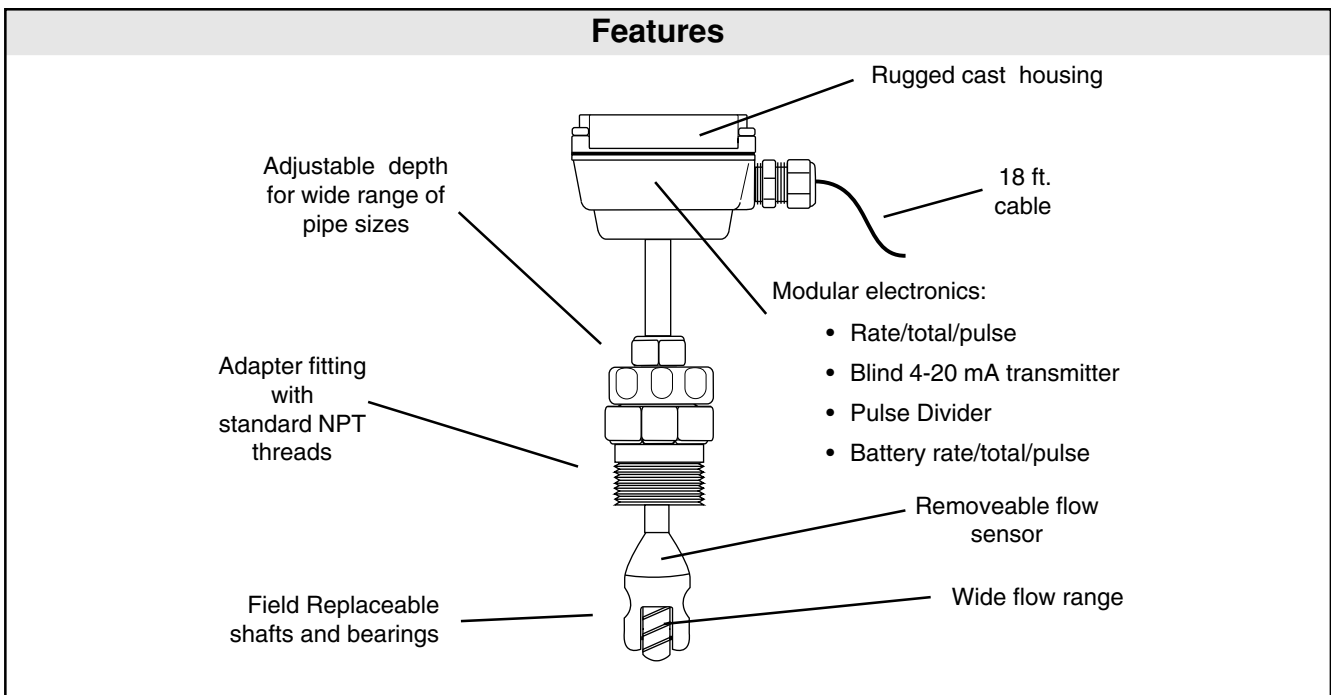

## Installation

**Piping.** For best results, the TX sensor should be installed with at least ten diameters of straight pipe upstream and five downstream. Certain extreme situations such as partially-opened valves are particularly difficult and may require more straight diameters upstream. All 100/200 Series sensors are supplied with a 1-1/2" male pipe thread fitting. Any fitting which provides the matching NPT female thread may be used. The installation procedure compensates for differences in height of the fitting.



These water meters are not recommended for installation downstream of the boiler feedwater pump where installation fault may expose the meter to boiler pressure and temperature. Maximum recommended temperature is 130°F (Plastic), 200°F (Metal).

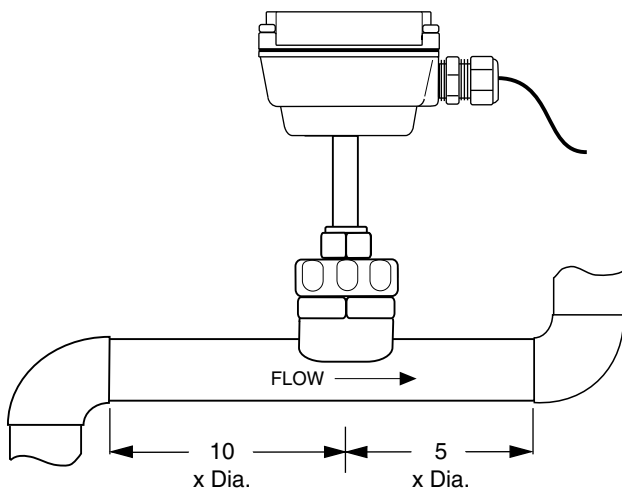

Horizontal is the preferred installation orientation, since it improves low-flow performance and avoids problems with trapped air. Bottom, top, and vertical pipe installations are all acceptable if required by the piping layout.

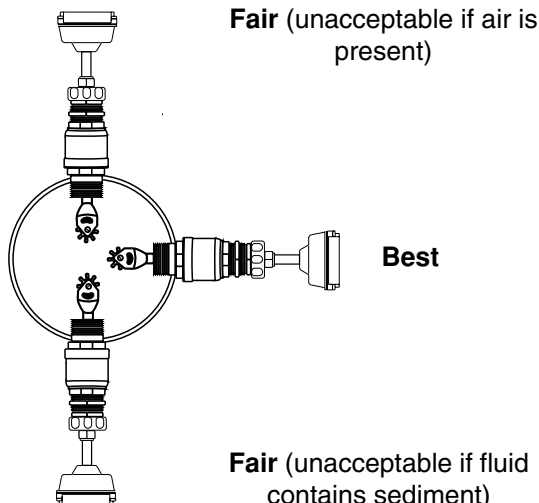

**Immersion.** The 100/200 Series standard sensors are not designed for continuous underwater operation. If this is a possibility, as in a flooded vault, a unit modified for immersion should be specified.

**Fitting Installation.** First cut a minimum 1-3/4" hole in the pipe. If possible, measure the wall thickness and write it down for use in depth setting, below. Then install the threaded fitting (saddle, weldolet, etc.) on the pipe.

**Meter Installation.** Remove the threaded adapter from the sensor. Using a thread sealant, install the adapter in the pipe fitting. *Do not overtighten.* Slide the meter through the adapter fitting. Engage the locking collar threads and turn until the collar stops, about 1-1/2 to 2 turns.

**Depth Setting.** It is important for accuracy that the sensor be inserted the correct depth into the pipe. Follow these steps:

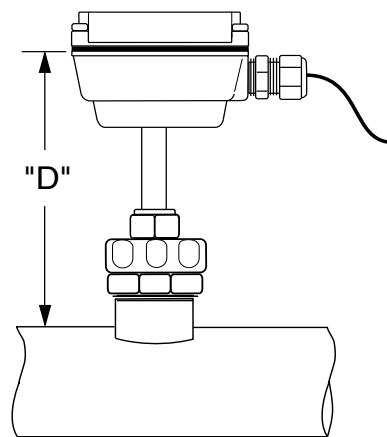

1. In Table 1, find the model of sensor which you have. Take Dimension **C** from this table for the pipe size.
2. Subtract wall thickness of your pipe to find Dimension **D**. Use Table 2 if you do not know the thickness.
3. Measuring from the outside of the pipe to the joint in the housing, as shown in the diagram, adjust the sensor to Dimension **D** and tighten enough to hold it there.
4. Line the conduit housing with the centerline of the pipe, as shown.
5. Check Dimension **D** one more time.
6. Tighten the compression nut fully.

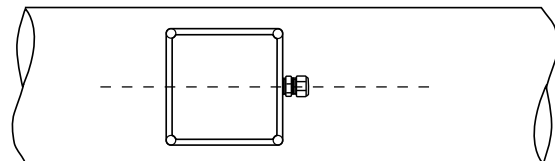

<b>Table 1: Dimension "C"</b>														
	<b>Nominal Pipe Size</b>													
	<b>2"</b>	<b>2-1/2"</b>	<b>3"</b>	<b>4"</b>	<b>5"</b>	<b>6"</b>	<b>8"</b>	<b>10"</b>	<b>12"</b>	<b>16"</b>	<b>24"</b>	<b>30"</b>	<b>36"</b>	<b>48"</b>
<b>TX101 B,S (Brass or Stainless)</b>		9.16	9.08	8.99	8.82	8.65	8.48	8.14	7.80	7.46	6.78	—	—	—
<b>TX201 B,S (Brass or Stainless)</b>		14.16	14.08	13.99	13.82	13.65	13.48	13.14	12.80	12.46	11.78	10.42	9.40	9.38

<b>Table 2: Pipe Wall Thickness</b>														
	<b>Nominal Pipe Size</b>													
	<b>2"</b>	<b>2-1/2"</b>	<b>3"</b>	<b>4"</b>	<b>5"</b>	<b>6"</b>	<b>8"</b>	<b>10"</b>	<b>12"</b>	<b>16"</b>	<b>24"</b>	<b>30"</b>	<b>36"</b>	
<b>IPS Steel Schedule(10S)</b>		0.109	0.120	0.120	0.120	0.134	0.134	0.148	0.165	0.180	—	—	—	—
<b>IPS Schedule (40)</b>		0.154	0.203	0.216	0.237	0.258	0.280	0.322	0.365	0.406	0.500	0.687	—	0.750
<b>IPS Schedule (80)</b>		0.218	0.276	0.300	0.337	0.375	0.432	0.500	0.593	0.687	0.843	1.218	—	—
<b>Copper Tubing (Type K)</b>		0.083	0.095	0.109	0.134	0.160	0.192	0.271	—	—	—	—	—	—
<b>Copper Tubing (Type L)</b>		0.070	0.080	0.090	0.100	0.125	0.140	0.200	—	—	—	—	—	—
<b>Copper Pipe</b>		0.157	0.188	0.219	0.250	0.250	0.250	0.313	—	—	—	—	—	—
<b>Class 52 Duct. Iron</b>		—	—	0.280	0.290	—	0.310	0.330	0.350	0.370	0.400	—	—	—

**Flow in gallons per minute at various velocities: Sched. 40 pipe**

Feet / sec. ▼	Nominal pipe size														
	2"	2-1/2"	3"	4"	5"	6"	8"	10"	12"	16"	24"	36"	38"	48"	
(0.2)	2.1	3.0	4.6	7.9	12.5	18	31.2	49.1	70	110	251	583	707	1127	
(0.5)	5.2	7.5	11.5	19.8	31.2	45	78	123	174	275	627	1460	1770	2820	
(1.0)	10.5	14.9	23	39.7	62.4	90	156	246	349	551	1250	2910	3530	5640	
(2.0)	20.9	29.8	46.1	79.4	125	180	312	492	698	1100	2510	5830	7070	11280	
(5.0)	52.3	74.6	115	198	312	450	780	1230	1740	2750	6270	14570	17670	28200	
(10.0)	105	149	230	397	624	900	1560	2460	3490	5510	12530	29140	35350	56400	
(20.0)	209	298	461	794	1250	1800	3120	4920	6980	11020	25060	58270	70700	112800	
(30.0)	314	448	691	1190	1870	2700	4680	7370	10470	16520	37600	87410	106050	170000	

**TX100/200 K-factors for various pipe sizes**

	Nominal pipe size															
	2"	2-1/2"	3"	4"	5"	6"	8"	10"	12"	16"	24"	30"	36"	38"	42"	
<b>PVC/Steel Sch. 40</b>	45.43	31.84	17.41	10.11	6.43	4.45	2.13	1.35	0.951	0.602	0.258	0.158	0.11	0.098	0.080	
<b>PVC/Steel Sch. 80</b>	51.62	35.97	19.49	11.19	7.07	4.08	2.33	1.48	1.05	0.660	—	—	—	—	—	
<b>Stainless Steel (10S)</b>	41.21	27.95	15.42	9.03	5.84	4.06	1.95	1.25	0.880	—	—	—	—	—	—	
<b>Stainless Steel (40S)</b>	45.43	31.84	17.41	10.11	6.43	4.45	2.13	1.35	0.951	—	—	—	—	—	—	
<b>Stainless Steel (80S)</b>	51.62	35.97	19.49	11.19	7.07	4.08	2.33	1.48	—	—	—	—	—	—	—	
<b>Copper Tubing (Type K)</b>	50.57	32.73	19.39	10.91	7.10	4.11	2.36	—	—	—	—	—	—	—	—	
<b>Copper Tubing (Type L)</b>	50.57	31.94	18.89	10.75	6.90	3.97	—	—	—	—	—	—	—	—	—	
<b>Copper Pipe</b>	45.65	31.05	17.48	10.24	6.39	3.61	2.12	—	—	—	—	—	—	—	—	
<b>Duct. Iron (Class 52)</b>	—	—	15.61	9.20	—	3.43	1.92	1.25	0.87	0.49	—	—	—	—	—	

**Connection.** Sensors are supplied with 18 ft. of cable. For sensors with no additional electronics, see diagram for color coding. For sensors with on-board electronics, see the manual accompanying the electronic module.

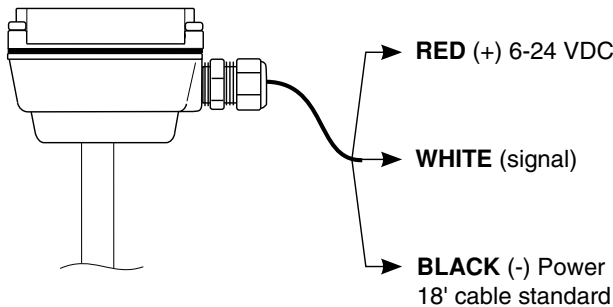

**Calibration (“K-Factor”).** In order to properly process pulses from the flow sensor, a number must be entered into the control to which the sensor is connected. This number, called the K-factor, is the number of pulses the sensor puts out per unit of fluid passing through the pipe. It is normally provided for SeaMetrics sensors in pulses per gallon, and is given on the chart “K-factors for Various Pipe Sizes.” These numbers are based on extensive testing, which has shown close agreement between different TX sensors in the same installation. Typically, most K-factor error can be attributed to installation variables, such as depth setting and fitting configuration.

It is occasionally possible to field calibrate a sensor by catching the fluid in a measured container and comparing with the number of pulses recorded. (To record individual pulses, set the K-factor on the control to 1.00.) This is especially desirable if the installation has less than the recommended length of straight pipe upstream of the sensor.

## Operation

**Theory.** In principle, an insertion flow sensor measures the velocity of flow at one point in the pipe, and flow rate and total can be inferred from this one point. Accuracy is decreased by any factor which makes the flow at the measured point unrepresentative of the entire flow stream. This of course includes distorted flow patterns caused by upstream fittings too close to the sensor. The worst offenders are fittings which increase the flow on one side of the pipe, such as partially-opened gate or butterfly valves. Fluid moving in a pipe does not flow at the same velocity. Toward the center of the pipe, fluid moves faster than at the wall, and the relationship between the two changes as overall flow rate increases. This change in the “velocity profile” can result in non-linearity, which means that the K-factor which is correct

for one flow rate may be incorrect for another. The recommended depth settings have been carefully chosen to minimize this source of error, and should be followed carefully, especially in the smaller pipe sizes.

**Flow Range.** These sensors are designed to operate at flow velocities of 0.2 to 30 feet per second. (See chart for conversion to gallons per minute.) If erratic readings are encountered at low flows, check the chart to see if flow is below minimum for the pipe size. The standard shaft and bearings should have a long life at continuous high flow.

## Repair



**Caution! Never attempt to remove a flow sensor when there is pressure in the pipe. Loosen the locking collar slowly to release any trapped pressure. If fluid sprays out when removing the sensor, stop turning and depressurize the pipe. Failure to do so could result in the sensor being thrown from the pipe, resulting in damage or serious injury.**

**Rotor Replacement.\*** Rotors are easily field-replaced. Shaft and rotor are a single unit, and are not replaced separately. If replacement is due only to normal shaft wear, bearing replacement is probably not necessary. If the rotor has been damaged by impact, the bearings should also be replaced. Rotor and bearings can be ordered as a kit (see parts listing, pg 6). Follow these steps:

1. Unscrew the threaded bearing housings to expose the shaft ends. If bearings are being replaced, back them completely out.
2. Remove the rotor. Put the new rotor in its place.
3. Thread in one bearing housing part way, then the other. Take care to start the end of the shaft into the bearing hole before tightening further.
4. Screw in bearing housings until they bottom. **Note: Do not use excessive force.**
5. Check for free spin. Blowing lightly on the rotor should result in it spinning rapidly and coasting to a smooth stop.

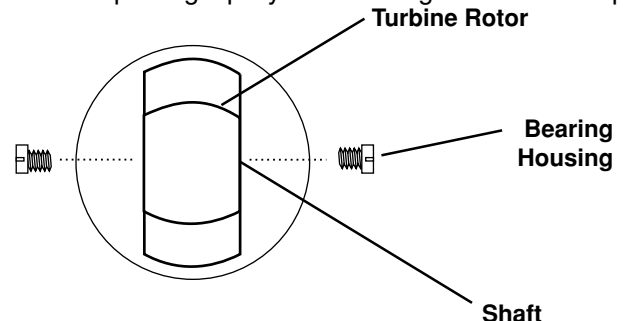

*\* Note that on ceramic shaft models the shafts are in the screws and the bearings are in the rotor. Follow the same basic procedure above. (#25945)*

**Troubleshooting.** The flow sensor has only one moving part, the rotor. If this is turning properly and there is no signal, the Hall-effect sensor is not operating properly. To check the signal, apply 12 VDC power to the red (+) and black (-) leads. Set a multimeter to voltage reading. Put the positive multimeter lead on the red wire and the negative lead on the white wire. Slowly turn the rotor. Voltage reading should swing between +12 Volts and 0 Volts as the rotor turns. If it does not, the Hall effect sensor is not working properly. Checking for continuity is not a useful test of these sensors.

All SeaMetrics flow sensors are repairable, and can be returned to the factory or distributor for repair. Please first obtain a Return Material Authorization (RMA) number.

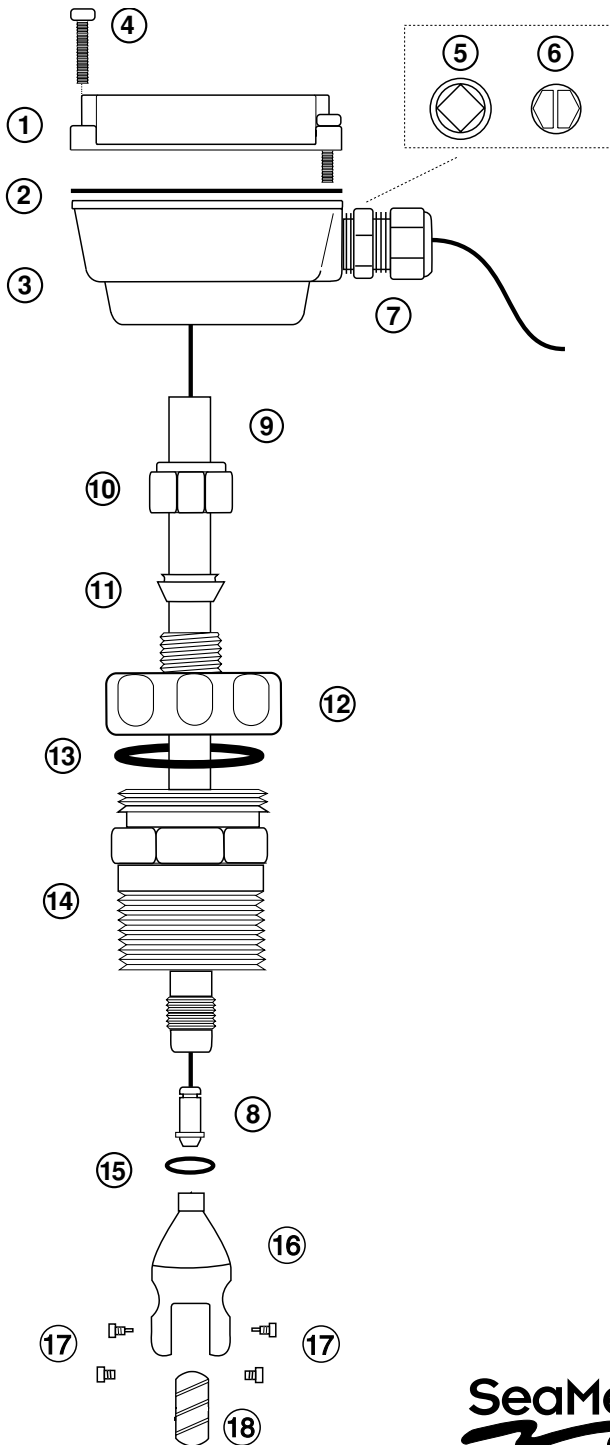

### TX Parts Listing

TX Parts Listing		
1	Upper housing	26181
2	Gasket	26211
3	Lower housing	29930
4	Housing screw	26229
5	Plug, steel	26073
6	Plug, plastic	26079
7	Strain relief	7655
8	Sensor w/cable	26310 (Standard - FT420, FT520)
8	Sensor w/cable	29953 (Micropower - FT415)
9	Tube	14130 (Brass - TX101B) 15130 (S/S - TX101S) 14131 (Brass - TX201B) 15131 (S/S - TX201S)
10	Compression nut	14199 (Brass) 15064 (S/S)
11	Ferrule	26065
12	Locking collar	14190 (Brass) 15070 (S/S)
13	Adapter fitting o-ring	26029
14	Adapter fitting	14180 (Brass) 15060 (S/S)
15	Rotor housing o-ring	16454
16	Rotor housing	25977 (Brass) 25978 (S/S)
17	Jewel bearing assy. Ceramic shaft holder	25901 (2 req'd) 16710 (2 req'd)
18	Turbine Rotor assy.	25946 (Polypro/Carbide) 25947 Kynar (for ceramic)
19	Rotor repair kit (consists of #17 & #18)	25930 Standard (Polypro/Carbide) 25945 (Ceramic/Kynar)

